



## ***Underwater Housing for Olympus Stylus 1S***

Product Number 6139.51

### **Product Registration**

Please register your product at **ikelite.com** within 15 days of purchase. Our product registration database is the best way for us to contact you in the event of a product update or recall.

## Table of Contents

<b>PREPARATION</b> .....	P. 3
<b>SPECIFICATIONS</b> - no camera installed.....	P. 4
<b>INCLUDED in the BOX</b> .....	P. 4
Parts of the Housing - Front View.....	P. 5
Parts of the Housing - Back View.....	P. 6
<b>HOUSING and CAMERA SETUP STEPS</b> .....	P. 7
STEP 1 - Camera Setup.....	P. 7
STEP 2 - Opening the Housing.....	P. 8
STEP 3 - Install Camera in Housing.....	P. 8 - 9
STEP 4 - Attach Hotshoe.....	P. 10
STEP 5 - Closing the Housing.....	P. 11
STEP 6 - Final Check.....	P. 11
STEP 7 - Entering the Water.....	P. 12
Removing the Camera from the Housing.....	P. 12
<b>STROBE COMPATIBILITY and USE</b> .....	P. 13
Strobe Compatibility.....	P. 13
Housing Conversion Circuitry.....	P. 13
Using Ikelite DS-series Strobes.....	P. 13
Using Non-Ikelite or Ikelite Non-DS-series Strobes.....	P. 13
Attach Ikelite Sync Cord to the Housing and Strobe.....	P. 14
Attach Fiber Optic Cord to Housing.....	P. 15
<b>RECOMMENDED ACCESSORIES and ATTACHMENTS</b> .....	P. 16
<b>SPARE PARTS</b> .....	P. 16
<b>MAINTENANCE</b> .....	P. 17

## Table of Contents - continued

Lens Port .....	P. 17
O-ring Storage .....	P. 17
Lubricant .....	P. 17
Housing Maintenance .....	P. 18 - 19
Control Maintenance .....	P. 19 - 22
<b>PHOTO TIPS</b> .....	P. 23
<b>TROUBLESHOOTING</b> .....	P. 24 - 26
<b>CUSTOMER SUPPORT</b> .....	P. 26
<b>LIMITED WARRANTY</b> .....	P. 27
<b>RETURNING PRODUCTS FOR SERVICE</b> .....	P. 27
<b>PRODUCT REGISTRATION</b> .....	Back Page

## PREPARATION

This product has been water pressure tested at the factory and is depth rated to 200 ft (60m). Thoroughly inspect and immerse the empty housing completely in water before installing a camera. If any fogging occurs or droplets of water enter the housing, do not install a camera. Clean the main housing o-ring and retest to make sure that the housing is watertight. Refer to the Troubleshooting section, **page 24**.

Please read your camera manual thoroughly to have a full understanding of each camera function.

If you are new to underwater photography, be sure to read the Photo Tips section, **page 23**.

## SPECIFICATIONS - no camera installed

<b>Depth Rating</b> .....	200 ft (60 m)
<b>Controls</b> .....	All important camera functions accessible except ..... Diopter adjustment dial, Side zoom lever, Front ..... control ring, Fn2 button, Front lever
<b>Buoyancy</b> .....	Slightly negative in freshwater
<b>Strobe Connection</b> .....	Ikelite bulkhead connector with built-in TTL circuitry
<b>Use Built-in Flash</b> .....	only to fire fiber optic strobes
<b>Housing Dimensions</b> .....	7.5 x 5.5 x 5.75 in (190 x 132 x 146 mm)
<b>Housing Weight</b> .....	3.1 lb (1.4 kg)
<b>Housing Material</b> .....	ABS-PC, acrylic, and acetyl construction
<b>Tray Mounts</b> .....	1/4-20 thread with 3-inch (76 mm) spacing
<b>Port</b> .....	3.0-inch diameter glass lens port

## INCLUDED in the BOX



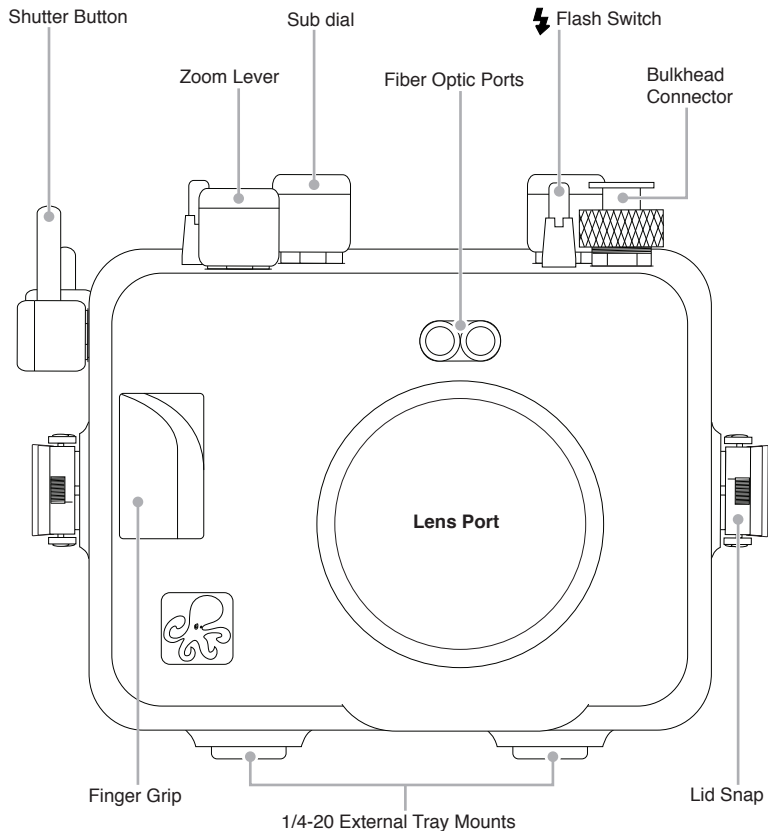

- Housing
- Port Cover
- Waterproof Bulkhead Cap (connected to external strobe connector)
- Lubricant
- Spare control tip package

## Parts of the Housing - Front View

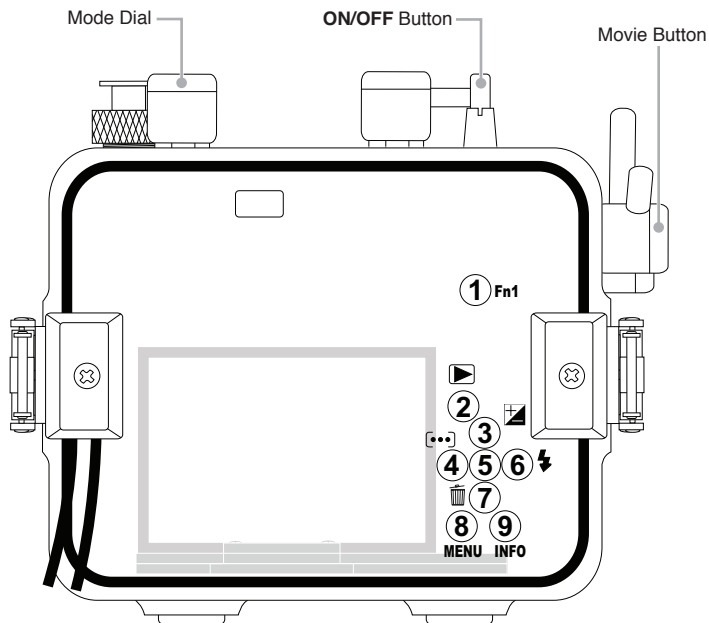

## Parts of the Housing - Back View



1. Fn1 Button
2.  Playback Button
3.  Exp. Comp. / UP Button
4.  AF Target / LEFT Button
5. **OK** Button
6.  Flash / RIGHT Button
7.  Erase / DOWN Button
8. **MENU** Button
9. **INFO** Button

## HOUSING and CAMERA SETUP STEPS

### STEP 1 - Camera Setup

Set Mode Dial to “A” or “M.”

**In the Custom Menu:**

Set AF Illuminat. to “Off.”

Set Metering to Center-weighted .

Set Touch Screen Settings to “Off.”

Set EVF Auto Switch to “Off.”

 This housing is designed for use with external strobes only. We recommend Ikelite DS-series strobes to take full advantage of the housing’s built-in TTL electronics. Non-Ikelite strobes can be fired manually using the proper cord.

Note: All other camera functions not mentioned should be set to the user preference based on the shooting environment.

## STEP 2 - Opening the Housing

Lid Snaps have a **Lock**.

1. Push Lid Snap Locks forward and lift as shown. Open opposing Lid Snaps simultaneously. Keep pressure on the Lid Snaps so they do not fly open quickly. Some Lid Snaps have a lot of spring tension once they go over center, so keep a firm grip on each Lid Snap. Lid Snaps may also be opened one at a time.
2. Remove the Housing Back.

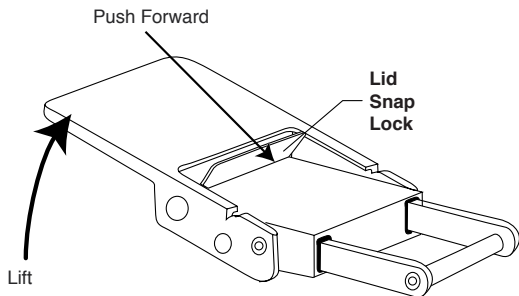

## STEP 3 - Install Camera in Housing

1. Make sure the camera battery is fully charged and a SD card is inserted into the camera. ⚠ Save existing photos on a separate storage device before formatting SD Card.
2. Pull top housing control knobs up for more clearance.
3. The Mounting Plate is secured to the inside bottom of the housing. The camera Mounting Tray slides into the Mounting Plate. Use your index finger and thumb to pull the Mounting Tray away from the Mounting Plate, **Diagram A, page 9**. Use your other thumb to apply opposite pressure against the bottom of the housing to assist in removal of the Tray if necessary.



## STEP 3 - Install Camera in Housing - continued

Diagram A

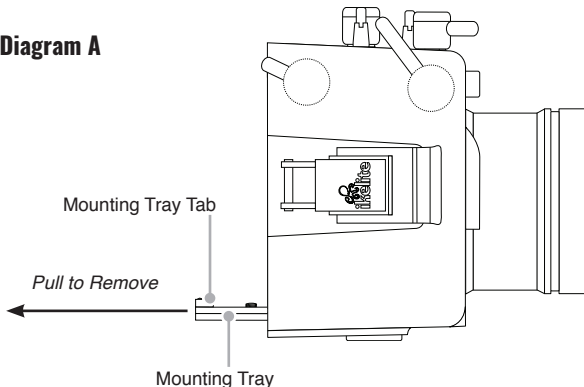

4. Using a coin or flathead screwdriver (preferred), secure the camera Mounting Tray to the camera tripod mount. Tighten camera firmly to avoid movement on tray. The Mounting Tray only attaches one way with the Mounting Tray Tab to the back of the camera. An additional 1/4-20-inch tray hole allows attachment to a land tripod stand.
5. Gently slide the camera with Mounting Tray back into the Mounting Plate. Using your thumbs, push against the Mounting Tray until it stops sliding forward into the Mounting Plate. Give the Tray an extra push to make sure it is properly seated all the way forward in the Mounting Plate and **no housing controls are in the way**.
6. Slide rubber eyecup up and off of camera viewfinder. This process will avoid unnecessary pressure on the camera once the housing back is attached.

## Step 4 - Attach Hotshoe

Slide the Hotshoe into the top camera mount until it stops.

**⚠** Hotshoe must be **all the way forward** in the camera mount to assure a good electrical connection with a strobe, **Diagram B, below**.

Make sure Hotshoe Cord does not interfere with controls.

**Diagram B - View from back of housing**

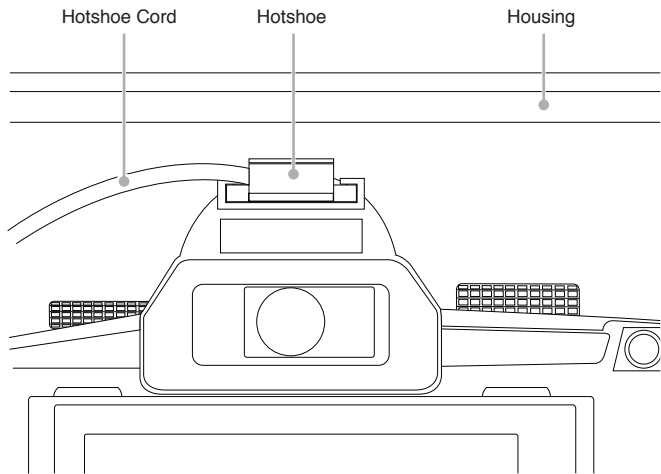

## STEP 5 - Closing the Housing

1. Place housing face down in your lap. Check to see that there is an o-ring on the housing back, and that it is clean and in its proper location.
2. Guide the back onto the housing front. Make sure the hotshoe wire is out of the way.

Once the back is properly installed, the o-ring should touch the housing all the way around.

There should be an even gap on each side of the housing between the housing and the back.

3. Lift the lid snaps so they are extended and place each lid snap into the corresponding hook on the housing back.
4. To close the housing, push down on the opposing lid snaps simultaneously until they snap into place. Be sure they are down far enough to engage the **Lid Snap Lock - Page 8**. The o-ring seal should now appear as a uniform black line when viewed from the back of the housing.

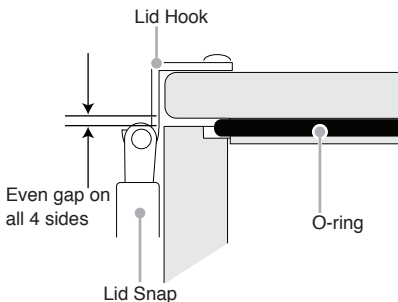

## STEP 6 - Final Check

The clear housing permits instant visual inspection of the camera and sealing surfaces as well as complete monitoring of controls and camera LCD screens. This housing has been factory water pressure tested to 200 ft (60 m). Once the housing is closed, recheck the o-ring seal. Double check the gap between the housing back and the housing. It should be even all the way around the housing. Look through the clear plastic back at the o-ring. You should see a darkened area or solid black line where the o-ring is compressed against the housing back. If you do not see an even black compression seal all the way around the back, open the lid snaps, reseal the housing back, and reclose the lid snaps. Visually check the seal again.

## STEP 7 - Entering the Water

Before entering the water, turn the camera on and operate each of the housing controls to get a feel for using the camera in the housing.

As soon as you enter the water, take a moment and check to see that the housing is properly sealed. We recommend you first water test the housing with no camera inside to assure a safe and watertight environment.

Next, check to see if there are any bubbles on the face of the lens port.

If there are, take your finger and remove them. If there are bubbles on the lens port they can produce soft focus spots in your photos or video.

## Removing the Camera from the Housing

1. Thoroughly dry housing.
2. Remove the housing back.
3. Remove the Hotshoe from the camera mount.
4. Pull back on both sides of the camera top to begin releasing the Tray from the Mounting Plate. Pull on the Tray Tab with your thumb and index finger. Slowly and gently pull the camera backward to separate from housing. Continue pulling the camera backward and remove from housing. We recommend doing this procedure on a desktop or solid flat surface to avoid dropping the camera.

If you are finished using the housing, remove the Mounting Tray from the camera bottom and slide it back into the Housing Mounting Plate. For storage and travel, remove the back o-ring and place in a small plastic bag. Place the bag inside the housing and reattach the housing back.

## STROBE COMPATIBILITY and USE

### Strobe Compatibility



- AF35..... not compatible
- DS50 ..... yes, above serial number 70000
- DS51 ..... yes
- DS125 ..... yes, above serial number 5000
- DS160, DS161 ..... yes
- DS200 ..... yes, above serial number 7163
- Non-Ikelite ..... yes, manual flash exposure only

### Housing Conversion Circuitry

This housing has integrated Ikelite designed Conversion Circuitry. The Circuitry provides real TTL flash exposure when used with Ikelite DS series strobes. The Circuitry is automatically activated once a DS series strobe is attached to the housing and turned on. Once attached, turn the strobe on first before turning on the camera. The circuitry cannot be powered up or used by non-Ikelite strobes.

### Using Ikelite DS-series Strobes

Set your DS-series strobe to “TTL.”

TTL flash   exposure compensation is done in the shooting menu under “Flash Control.”

### Using Non-Ikelite or Ikelite Non-DS-series Strobes

The Conversion Circuitry is automatically disabled when used with a Non-Ikelite or Non-DS-series Strobe. These Strobes can be used in their manual mode utilizing any power settings provided on the Strobe. To attach a Non-Ikelite strobe to the housing, go to [ikelite.com](http://ikelite.com) to select the proper cord.

## Attach Ikelite Sync Cord to the Housing and Strobe

The Ikelite Housing and Strobe Bulkheads are designed to accept sync cords with Ikelite 5 pin connector fittings.

1. Lightly lubricate the Sync Cord O-rings. Use **ONLY** Ikelite lubricant (supplied with housing). Other lubricants may cause the o-rings to swell and seal improperly.
2. Remove Bulkhead Caps from Housing Bulkhead and Strobe Bulkhead.
3. Line up the Sync Cord Pins with the corresponding Bulkhead Receptacles, **Diagram C**. Gently insert Sync Cord ends into each Bulkhead. Either Cord End may be attached to a component. **DO NOT** force this installation. If the Sync Cord does not seat properly inside the Bulkhead, then the Pins and Receptacles are improperly aligned (repeat Step 3).
4. Tighten the Knurled Nuts snugly using your Index finger and thumb. **DO NOT** use pliers or other tools to tighten the Knurled Nuts.
  - *Always remove the Sync Cord from your Housing and Strobe when not in use and replace the Bulkhead Caps.*

**Diagram C**

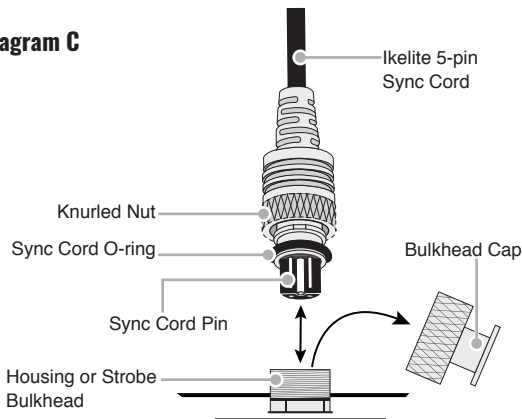

## Attach Fiber Optic Cord to Housing

The Ikelite Housing is designed to accept most fiber optic sync cords. The Fiber Optic Mount allows attachment of up to two Fiber Optic Cords.

1. Lightly lubricate the Sync Cord O-rings.
  2. Line up and insert the Fiber Optic Cord into the corresponding Fiber Optic Mount, **Diagram D**. Either mount receptacle can be used. Make sure cord is mounted securely.
  3. Attach other cord end to the fiber optic strobe.
- *Always remove the Fiber Optic Cord(s) from your Housing and Strobe when not in use.*

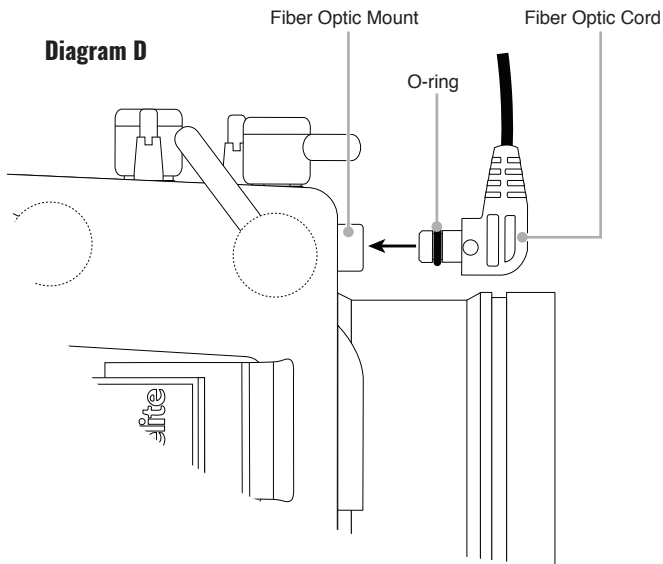

## RECOMMENDED ACCESSORIES and ATTACHMENTS

### Optional Tray + Release Handle 9523.63

The optional aluminum tray with release handle comes with the necessary hardware to mount to your Ikelite housing.

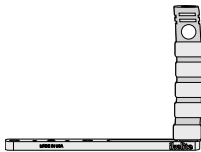

### Optional Tray + Dual Handles 9523.64

Attaching an optional Tray + Dual Handles will add stability and gripping point(s) for comfortable use of the housing. Add a second strobe to eliminate shadows and evenly light your subjects.



## SPARE PARTS - available through Ikelite or any Ikelite Dealer

- 0184.2 Silicone lubricant 2cc reclosable tube
- 9104.5 Waterproof bulkhead cap
- 0110 Main o-ring
- 0200 Port Cover



## MAINTENANCE

### Lens Port

Treat the glass in the lens port as a camera lens. After use, rinse and gently dry the outside lens port to avoid water spotting. To clean, use a mild soap solution or lens cleaner. It is NOT necessary to remove the Port for cleaning. Do not rinse the inside of the Port.

**Do not use alcohol or window cleaner on the Lens Port.**

### O-ring Storage

When storing the housing, remove the main housing o-ring. Lightly lubricate the o-ring until it appears shiny and place in a small resealable plastic bag. Use only Ikelite lubricant. Place the bag inside the housing and store until needed.

### Lubricant

Ikelite provides silicone lubricant with the housing. We recommend you use **only** Ikelite lubricant on Ikelite products. Other brands may cause the main housing o-ring to swell and not seal properly.

Use only enough lubricant to lightly cover the main housing o-ring or lubricate a sticky control. Wipe off any excess lubricant with a clean cloth. Lubricant is not a sealant; it is used to reduce friction. Excessive lubricant can collect sand and dirt which may interfere with proper sealing.

#### **CAUTION:**

 **Never use spray lubricants as the propellant ingredient can cause the plastic housing to crack or o-rings to swell.**

## Housing Maintenance

Your Ikelite Digital Housing should be given the same care and attention as your other photographic equipment. In addition to normal maintenance, we recommend that the housing be returned to Ikelite periodically to be checked and pressure tested.

- Do not leave the camera and housing in direct sunlight for prolonged periods. Heat may damage the camera.
- Do Not ship the camera in the housing.
- Before using the housing, always check the tightness of the set screw in each control knob. Check each control gland penetrating the housing to make sure they are tight. There is a slight chance that either could vibrate loose during travel.
- Keep the main housing o-ring clean and lightly lubricated. To lubricate, remove the o-ring from the back. Put a small amount of Ikelite lubricant on your fingers. Pull the o-ring through your fingers to apply a thin coating of lubricant. Only apply enough lubricant to make the o-ring feel slick.

**Do Not stretch the o-ring.**

## Housing Maintenance - continued

This light coating of lubricant will help to keep the o-ring from drying out and will help to show a dark sealing line when the housing back is properly sealed.

- Keep area where the o-ring fits and sealing surface of the housing clean.
- Rinse the housing exterior thoroughly in fresh water after each saltwater use. Depress push buttons repeatedly in fresh water to eliminate trapped saltwater. Dry with a soft cloth. Dry lens port to eliminate water spotting. After several uses in saltwater, soak the housing exterior in a mild soap solution; rinse and dry before storing. When storing the housing, remove the back o-ring, lightly lubricate, and place in a plastic bag. Place the plastic bag with o-ring inside the housing for safe keeping.
- If removing a housing push button, Do Not re-use the E-clip. Contact Ikelite for replacement E-clips (part 0319.12).
- Leave lid snaps in the open position when not using the housing for extended periods.
- Always disassemble and clean optional Tray/Handle(s) before storage.

## Control Maintenance

Ikelite controls are designed to provide years of reliable service with minimal maintenance.

- Push button controls normally require no maintenance other than rinsing in freshwater after saltwater use. Depress each push button in fresh water several times to eliminate trapped saltwater. If a push button control becomes difficult to push or if it sticks when depressed, soak the housing in luke warm fresh water. After a few minutes, operate the push button. If this does not correct the problem, return the housing to Ikelite for maintenance. If you are on a trip and unable to return the housing immediately, a push button may be lubricated by pressing and holding the push button all the way in. Then, use your finger or other small non-metal object to place a small amount of lube at the base of the shaft inside the housing.

## Control Maintenance - continued

Press and release the push button several times until the lube is worked up into the o-ring.

After completing this procedure, close the housing and submerge it in water without the camera inside.

Check the control for watertightness.

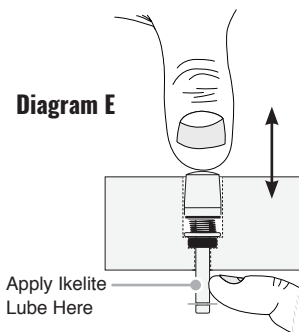

Ikelite controls are designed to provide years of reliable service with minimal maintenance.

In the unlikely event one of the control shafts sticks or becomes difficult to operate, you can remove the control from the housing and lubricate it, or return the housing to Ikelite for maintenance.

Your housing may feature both **round** and **hex** style control glands. To remove a control in a round style gland, **Diagram F, page 22**, loosen the set screw in the knob (hex head wrench required); remove the knob. If there is salt or dirt build-up on the exposed control shaft, clean the shaft. Open the housing and gently slide the control shaft out of the control gland. Clean and lightly lubricate the shaft and o-rings, including the large end of the shaft.

If there is a shutter spring on the Control Shaft, make sure it is in its proper position. Rotate the Shaft back and forth slightly to aid installation back into the Control Gland. Replace the knob with the Set Screw over the Control Flat. The Set Screw in the knob should be tightened down against the flat area on the Control Shaft so the knob does not turn on the shaft.

## Control Maintenance - continued

- Some of the controls have long shafts and feature a **hex** style control gland. These controls can be pulled out, exposing the shaft, **Diagram G, page 22**. To lubricate the control, gently pull on the knob until the stainless steel shaft is exposed. Lightly lubricate the shaft, then move the shaft in and out several times. This will lubricate the x-ring in the Ikelite control gland. This should be done before using the housing after a prolonged storage period, or once a week when the housing is in constant use.
- Some of the controls have a short shaft and cannot be pulled out exposing the shaft for lubrication. In the unlikely event one of these controls sticks or becomes difficult to operate you can remove the control from the housing and lubricate it, or return the housing to Ikelite for maintenance. To remove the control, **Diagram H, page 22**, loosen the set screw in the knob (hex head wrench required); remove the knob. If there is salt or dirt build-up on the exposed control shaft, clean the shaft. Open the housing and gently slide the control shaft out of the control gland. Clean and lightly lubricate the shaft, including the end of the shaft. Slide the shaft back into the control gland and gently slide the shaft back and forth a few times without fully removing the shaft from the gland. Replace the knob noting the flat area on the shaft. The set screw in the knob should tighten down against the flat area on the control, so the knob does not turn on the shaft.

Close housing **without** a camera inside and water pressure test in a bathtub or swimming pool. Rotate\* the knobs to make sure the housing is watertight and the gland was installed properly. Check all controls while the housing is submerged.

 **\*Caution:** If your housing has a shutter spring, **DO NOT** rotate the shutter control more than 1/16th of a rotation, otherwise, you may accidentally bend the shutter spring or cause the spring to “pop off” the control shaft.

## Control Maintenance - continued

**Diagram F**

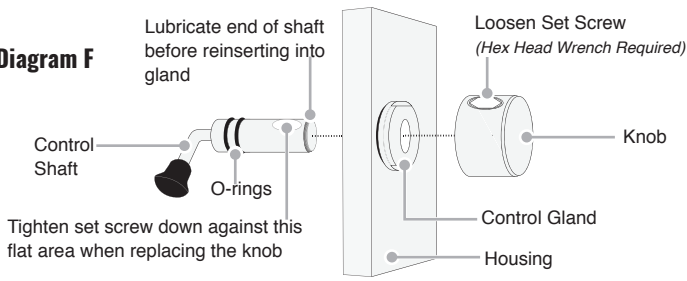

**Diagram G**

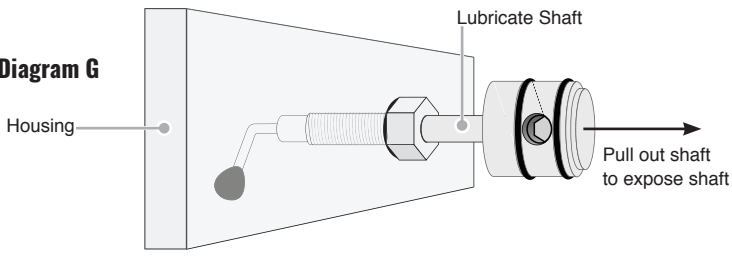

**Diagram H**

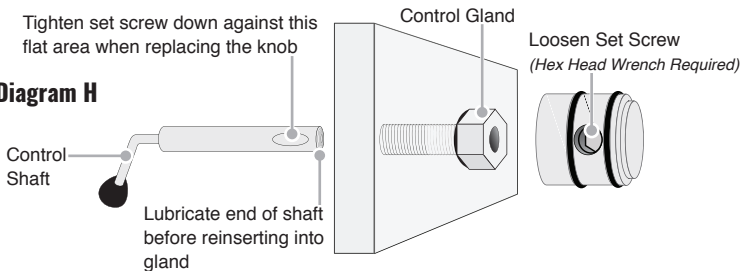

## PHOTO TIPS

- The number one rule in underwater photography is to eliminate as much water between the camera and subject as possible. Get as close as you can to the subject, then use the zoom. If you are using flash for still photos, subjects beyond 6 ft (1.8 m) will not have much color regardless of strobe power.
- Photograph in clear water; do not stir up the sand or silty bottom. If backscatter becomes a problem in the environment you are photographing, an external flash will help eliminate much of the backscatter or small floating debris in the water which reflects light.
- Many digital cameras have a slight lag time between when you press the shutter release button and the camera actually takes the picture. Hold the housing steady a second or two after pressing the shutter release button.
- Do not shoot down on subjects as they will quite often blend into the background and be difficult to see in the photograph. Shoot subjects straight on or shoot up at a slight angle using the blue water as a contrasting background.
- When using daylight or flash, if your camera consistently over or underexposes the image, you may want to adjust your camera's exposure compensation  settings.
- If you error in exposure, it is better to have the image slightly underexposed rather than overexposed. An overexposed image is missing color information which cannot be adjusted in a photo processing program. A slightly underexposed image has color information that can be adjusted.
- It is important to respect all living creatures underwater, including people, marine life, and coral. While we encourage people to get close to their subjects when taking a photograph, they should not touch, lie on, or in any way disturb the things they find underwater.

## TROUBLESHOOTING

Problem	Solution
<b>Push buttons or controls are sticky or hard to operate</b>	<ul style="list-style-type: none"><li>- Remove the camera and rinse the closed housing in fresh water. Vigorously press each push button in and out several times to release any trapped saltwater or debris.</li><li>- Press a sticky push button all the way in and place a small amount of lube on the small end of the push button shaft at it's base. Release and depress the push button several times to distribute the lube, <b>Diagram E, page 20</b>.</li><li>- If a larger gland style control is sticky, grab the control knob, pull it out, and then push back in. If still sticky, see the Control Maintenance section, <b>pages 19-22</b>.</li><li>- Return housing to Ikelite for routine maintenance.</li></ul>
<b>Image is over/underexposed, or a corner of the image is dark</b>	<ul style="list-style-type: none"><li>- When using fiber optic strobes, check that the built-in flash is firing when taking picture. Camera flash should be forced "on".</li><li>- Check that the external strobe is firing when taking a picture. Make sure it is turned on, set properly, and its battery is charged.</li><li>- Check any corded connection points.</li><li>- Change camera shutter speed or aperture.</li><li>- Move closer to or further away from the subject.</li><li>- Adjust Exposure Compensation.</li></ul>



Problem	Solution
<b>Camera does not take a picture</b>	<ul style="list-style-type: none"> <li>- Install a fully charged battery.</li> <li>- There is not enough available light for the camera to properly focus. Add a focusing light or strobe with a built-in focusing or video light to your system.</li> <li>- Select a center focus point in your camera menu.</li> </ul>
<b>Housing is hard to close</b>	<ul style="list-style-type: none"> <li>- Make sure the camera is mounted properly in the housing and controls/cord are out of the way.</li> <li>- Main housing o-ring is not seated properly.</li> </ul>
<b>Fogging occurs on the Lens Port</b>	<ul style="list-style-type: none"> <li>- Humid air is trapped inside the housing. The camera produces heat and may condense any trapped moisture forming fog on the lens port. Close the housing in an air-conditioned room or vehicle, or in front of an air-conditioner.</li> <li>- The housing should not be in direct sunlight for an extended period of time.</li> <li>- Purchase desiccant packs also known as moisture munchers from a local camera store. Place one or two new packs in your housing before each day of diving.</li> <li>- If moisture or water droplets are present around the controls or sealing areas, return the housing to Ikelite for evaluation.</li> <li>- Clean the main housing o-ring and sealing surface of the housing</li> </ul>

Problem	Solution
<b>Pictures are too blue or too green</b>	<ul style="list-style-type: none"><li>- Add an external strobe.</li><li>- Move in closer to your subject when taking a picture.</li><li>- Add an optional color correcting filter to the Housing Port.</li><li>- Strobe is not firing. Check corded connection points.</li><li>- Use custom (manual) white balance. Reset for each working depth or when attaching a color correcting filter to the camera lens.</li></ul>

## CUSTOMER SUPPORT

Please read the troubleshooting section of this instruction manual before contacting Ikelite Customer Support.

***Ikelite Underwater Systems  
Service Department  
50 West 33rd St.  
Indianapolis, IN 46208 USA***

**Email:** [ikelite@ikelite.com](mailto:ikelite@ikelite.com)

**Phone:** 317-923-4523

## LIMITED WARRANTY

This Ikelite product is warranted against any manufacturing defects for a period of one (1) year from the original date of purchase. Defective products should be returned to Ikelite postage paid. Ikelite will, at its sole discretion, repair or replace such products, and will return to customer postage paid. All other claims of any nature are not covered. Except as mentioned above, no other warranty expressed or implied applies to this Ikelite product.

## RETURNING PRODUCTS FOR SERVICE

Ikelite is most interested in performing any service to ensure that all products perform as intended. Evidence of purchase date must be provided to obtain warranty service.

No prior authorization is required. You may return directly to us or through your dealer. Please include a brief description of the problem, any relevant email correspondence, and/or instructions on what you want us to do.

Always include name, shipping address, email address, and phone number inside of the package. Send postage paid to:

**Ikelite Underwater Systems**  
**Attention: Service Department**  
**50 West 33 Street**  
**Indianapolis, IN 46208 USA**

*No reimbursements for postage paid will be issued.*

*You may also want to insure the package.*

## Returning Products for Service - outside the United States

For the separate international customs documentation form that you complete to accompany the shipment, please state or designate that the enclosed products were originally manufactured in the USA and are being returned to the manufacturer for repair service. Value of the equipment listed for customs purposes should be zero.

## **PRODUCT REGISTRATION**

Please go to **ikelite.com** to register your Ikelite housing within 15 days of purchase.



**Ikelite Underwater Systems  
50 West 33rd Street  
Indianapolis, IN 46208 USA**

**ikelite.com**

© 2016 Ikelite Underwater Systems

6139.01\_Olympus\_Stylus\_1s\_1-0416