

Thank you for purchasing INON S-220.

## **DO NOT Turn On with Slave Sensor Being Exposed**

**Always attach the " Rubber Cap for Sensor" to the Slave Sensor unless an Optical D Cable is attached. The strobe can fire unexpectedly in response to ambient light if power on with the Slave Sensor exposed.** If the strobe flashes at close range of the eyes, irreparable damage to eyesight may result. Temporary visual impairment may result, making it difficult to perform safety-related operations.



**Rubber Cap for Sensor**  
**\*preinstalled**



## **DO NOT Leave S-220 on Sand Area**

**The Main Mode Switch/Advanced Cancel Circuit Switch have a magnet and can collect iron sands around the switch causing interference from proper operation.** If you observe iron sands around switches, **do not move switches as practically as possible and use air blower to blow them away from the direction indicated by arrows in below right image.** In case iron sands are trapped and can not take them away (you may not feel clicking of the switch as like before), the unit needs to be checked and repaired properly. Please contact your purchasing dealer or Inon authorized service center.

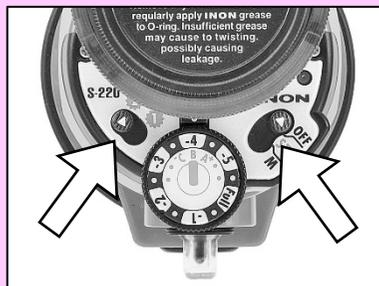

\*See reverse page

## Compatible Battery, Operational Limitation

Please use your S-220 with compatible batteries and within following operational limitations to avoid possible heat generation /degradation of light emitting part and inner electrical circuit etc.

### Compatible battery

Four battery types can be used with this product, as below.  
Make sure to use fresh and good quality 4 x AA size batteries of same model/ manufacture.

- Panasonic AA "eneloop" (Model: BK-3MCC) **【Recommended】**
- Panasonic AA "eneloop pro" (Model: BK-3HCD) **【Recommended】**
- AA NiMH Battery other than above (1.2V) [good quality]
- AA Alkaline Battery (1.5V)
- AA Lithium Battery (1.5V)

### Limitation on repeated flashes

The table below explains maximum number of repeated flashes. Make sure to cool down light emitting part and inner electrical circuit of the strobe by NOT making flash for at least about 5 minutes.

Also additional 10 minutes cooling-down period is required by turning OFF the Main Mode Switch after total number of flashes according to the table below.

Also take extra cooling-down period to maintain initial performance of the product according to frequency of usage and generated heat.

Main Mode Switch	S-220 switches setting [S-220 flash output]	Maximum number of repeated flashes	Total number of flashes
	Control Dial		
M	Full, -0.5, -1	10 flashes	50 flashes
	-1.5, -2, -2.5, -3	30 flashes	100 flashes
	-3.5, -4, -4.5, -5, -5.5	50 flashes	150 flashes
S-TTL	-- [Marginal far end] (*2)	10 flashes	50 flashes
	-- [approx. -1.5EV. through -3EV.] (*3)	30 flashes	100 flashes
	-- [less than approx.-3.5EV.] (*4)	50 flashes	150 flashes

(\*1) Repeated flashes at or less than 30 seconds intervals.

(\*2) Actual flash output is marginal far end of exposure range (approx. Full through -1EV.)

(\*3) Actual flash output is approximately -1.5EV. through -3EV.

(\*4) Actual flash output is less than approximately -3.5EV.

As of July, 2023

# INON

# S-220

## User Manual

Thank you for purchasing INON S-220 strobe.

- Before using, please make sure to read this user manual, **Safety Precautions** and **Safety Precautions on Batteries**.
- Always ensure proper operation of the S-220 strobe according to this user manual.
- Keep this user manual handy for quick reference.

### Contents

Check Package Contents .....	1
Safety Precautions .....	2
Safety Precautions on Batteries .....	5
Before Using the S-220 Strobe .....	6
Prevent Accidental Flooding .....	7
Nomenclature .....	9
Controls .....	10
Displays .....	11
Preparation .....	12
O-ring Maintenance .....	12
Load Batteries .....	12
Options to Connect to a Camera .....	14
Connecting with a Camera .....	15
Taking a Photo .....	16
Shoot with Optical Connection (Optical D Cable) .....	16
Using Strobe Dome Filter S .....	20
Maintenance and Storage .....	21
Troubleshooting .....	24
After Service .....	25
Specifications .....	26

## Check Package Contents

Check that the following items are included in the package before use. If any of the following items are missing, please contact your purchasing dealer.



S-220 Strobe  
(★ are preinstalled)



★Strobe Dome Filter S  
[SOFT]



Strobe Dome Filter S  
[ND]



★Rubber Cap for  
Sensor



INON Grease

● This user manual

## Safety Precautions

- Before using, please make sure to read [Safety Precautions] and [Safety Precautions on Batteries to ensure safety and proper operation of the product.
- Safety precautions described here are to prevent your and other people's injuries or damage.
- When using accessories, read through respective manual(s) as well.



**DANGER**

Failure to observe the precautions by this symbol may lead to high possibility of serious injury or death.

**NEVER attempt to disassemble, modify the strobe**

**DO NOT touch exposed internal portions as a result of damage**

The high-voltage circuitry in the strobe may lead to electric shock even without batteries. Those activities could cause malfunction/flooding.

**STOP operating the strobe (including function check on land) if any water is observed inside strobe or strobe operates improperly.**

The product could burn or explode leading to serious injury or malfunction/flooding may cause abnormal operation leading personal injury. Immediately turn OFF the strobe and execute controlled ascent to surface then wipe off the strobe completely and unload batteries not to get burned. Contact your purchasing dealer for repair.

**Prevent water/foreign substances from entering strobe**

**Avoid replacing batteries in splashed or humid area**

Malfunction causing abnormal operation or flooding could lead to personal injury.

**DO NOT fire the strobe/turn on the Focus Light in front of person's (particularly an infant) eyes.**

The flash/light may cause irreparable injury to the eyes or cause temporary visual impairment to avoid safety relating operations.

**DO NOT cover/touch light emitting part by hand during flashing or after rapid flashing**

Light emitting parts becomes hot and may cause burn. Malfunction causing abnormal operation or flooding could lead to personal injury.

**DO NOT use the product in area with flammable or explosive gas.**

Using the product in such area could cause fire ignition, explosion or fire.

**DO NOT use organic solvent like alcohol, benzene or thinners, or antirust, lubricant, polish or detergent (especially alkaline detergent) to clean the strobe.**

Using those chemicals may cause damage on the product or fire ignition, explosion or fire.

**Keep the strobe out of reach of children**

Their inability to read and understand warnings may lead to serious injury. They may swallow parts of the strobe or batteries. See a doctor immediately if a child swallow parts or batteries.

**DO NOT fire/turn ON the strobe on land except functional check.**

**DO NOT fire the strobe shorter than 30 sec. interval during functional check on land.**

**Make sure to rest the product for 5 min. when the product has been fired 10 flashes at FULL or FULL -1.0 E.V. in 30 sec. underwater.**

Excessive heat can damage inner circuitry.

**DO NOT use the strobe in aircraft or proximity of medical equipment.**

The strobe can interfere with flight instruments or medical equipment.

**Turn OFF the strobe when not in use. (Never leave the strobe with power ON)**

**Unload flat batteries immediately**

Flammable gas may be generated from batteries to cause explosion of the product. Loaded flat batteries may leak or generate heat to cause fire, personal injury or damage on premises.

**Unload batteries when not in use or during transportation**

Vibration etc. may cause unexpected operation leading to fire or personal injury. Loaded batteries may leak or generate heat to cause fire, personal injury or damage on premises.

**DO NOT apply heat on the product**

The product may be burned or exploded to cause serious personal injury. Malfunction causing abnormal operation or flooding could lead to personal injury.

**CAUTION**

Failure to observe the precautions by this symbol may result in possibility of injury or property damage

**DO NOT apply strong vibration or shock to the product by dropping or hitting against something. Take special care not to apply strong shock to protruded Slave Sensor of the strobe.**

Damage to the strobe may cause malfunction or flooding which may cause fire or personal injury.

**DO NOT "jump" into water with the strobe or photographic equipment** Malfunction, abnormal operation, flooding or strobe setting change caused by shock when entering water may cause personal injury.

**DO NOT leave/store the strobe subject to direct sunlight or high temperatures, such as beach, boat deck, dashboard or trunk of a car.** Abnormal operation caused by malfunction or deformation of outer body may lead to flooding to cause fire or personal injury.

**Remove Battery Box Outer Cap when transporting in an aircraft or through a place with lower air pressure than ground level** This product is not designed to have lower pressure inside and may lose water-proof property leading to flooding to cause personal injury.

**DO NOT leave the S-220 on sand area**

**The Main Mode Switch/Advanced Cancel Circuit Switch have a magnet and can collect iron sands around the switches causing interference from proper operation.** In the case you observe iron sands around the switch, do not change switch position as practically as possible and take care of it according to Maintenance and Storage (P.21).

# Safety Precautions on Batteries



**DANGER**

Failure to observe the precautions by this symbol may lead to high possibility of serious injury or death.

**DO NOT use batteries other than batteries specified in this manual.**

Usable batteries :

- Panasonic AA “eneloop” rechargeable battery (Model: BK-3MCC) **[Recommended]**
- Panasonic AA “eneloop pro” rechargeable battery (Model: BK-3HCD) **[Recommended]**
- AA NiMH Battery other than above (1.2V) [good quality]
- AA Alkaline Battery (1.5V)
- AA Lithium Battery (1.5V)

**DO NOT throw a battery in a fire or heat it. Never attempt to disassemble or short-circuit a battery.**

**DO NOT immerse battery in water or wet it.**

**DO NOT use abnormal battery causing leakage, discoloration, deformation or outer damage**

**DO NOT mix old and new batteries, recharged and discharged batteries or batteries of different capacities, types, brand or manufacturer.**

**DO NOT attempt to recharge non-rechargeable batteries.**

**Always use specified charger by battery manufacture. Follow any other instructions indicated by battery/battery charger user manual.**

**DO NOT load batteries with the +/- battery terminal reversed.**

**Follow any other instructions indicated on battery/battery user manual.**

**Dispose batteries in accordance with all applicable regulations.**

**If a battery leaks\*\*\***

- Immediately move away from fire to avoid possible risk of fire, explosion.
- If battery fluid contacts eye, immediately wash with a lot of clean fresh water without rubbing it and consult a doctor.
- If battery fluid gets into the mouth, immediately wash with a lot of fresh water and consult a doctor.
- If battery fluid contacts skin or cloth, immediately wash with a lot of fresh water.

## Before Using the S-220

Make sure to take test shots before using the S-220 underwater to make sure it works properly especially before taking important shot(s). INON Inc. cannot indemnify anyone for any loss/damage regardless of whether it is directly/indirectly caused by malfunction/flooding of the product .

# Prevent Accidental Flooding

The S-220 is waterproof due to a yellow O-ring (herein after “O-ring”) that seals the internal circuitry, enabling underwater use. This O-ring must be inspected each time before using strobe to ensure waterproof integrity. Equally important are O-ring contact surfaces. Always check the contact surfaces for contaminants or scratches.

## ■ O-ring Inspection Location



Battery Box

→ Check condition of Battery Box  
O-ring, O-ring groove



Battery Box Outer Cap

→ Check condition of O-ring  
contact surface and visually  
check if the O-ring is uniformly

## ■ O-ring Inspection

These are the essential factors below ensuring waterproof property:

- O-ring itself
- O-ring contact surfaces
- O-ring grooves
- If an O-ring is properly seated in a groove
- Grease

### 1 Is O-ring twisted?

→ Remove the O-ring and re-install properly



### 2 If the O-ring, O-ring Contact surface or O-ring groove is cut, cracked, deformed or swelled.

→ O-ring: Replace with new O-ring (option)

→ O-ring contact surface, O-ring groove: Not usable as it is.  
Please consult with your purchasing dealer for repair.

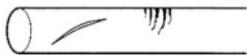

### 3 If hair, sand, lint or other debris is attached.

→ O-ring, O-ring groove:  
Remove O-ring and wipe-off debris  
completely, apply grease and re-install the O-ring.

→ O-ring contact surface: Wipe-off debris completely

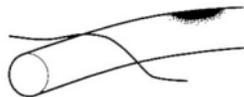

## ■ How To Apply INON Grease

**⚠ Use INON Grease Only**

The battery box O-ring may be cut or damaged by friction, so add a little extra grease to the O-ring and its O-ring contact surface. Also, slowly rotate the battery box outer cap whenever opening/closing Battery Box Outer Cap not to apply excessive load to the O-ring.

## ■ Installing/Removing O-ring

Be sure to follow below procedure whenever to install/remove an O-ring to avoid fatal flooding caused by poor O-ring handling.

- 1 To remove, lightly squeeze from the sides so it bulges out from one side, grasp and pull off slowly.

**⚠ Never use sharp material to remove an O-ring**

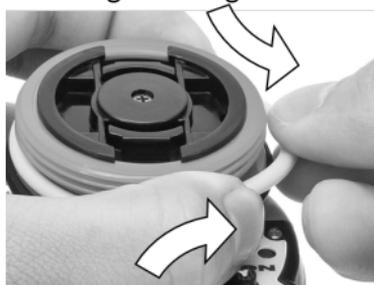

- 2 Clean any residual grease from the O-ring and O-ring groove, and check the condition of both surfaces.



- 3 Using your fingertips, apply a thin uniform film of INON grease on the O-ring. Use the packaged spare O-ring if the original one shows any deformation/swell/crack/cut or other irregularity.

- 4 Gently install the O-ring in the O-ring groove, not stretching it too much, and making sure it is seated uniformly and not twisted.



# Nomenclature

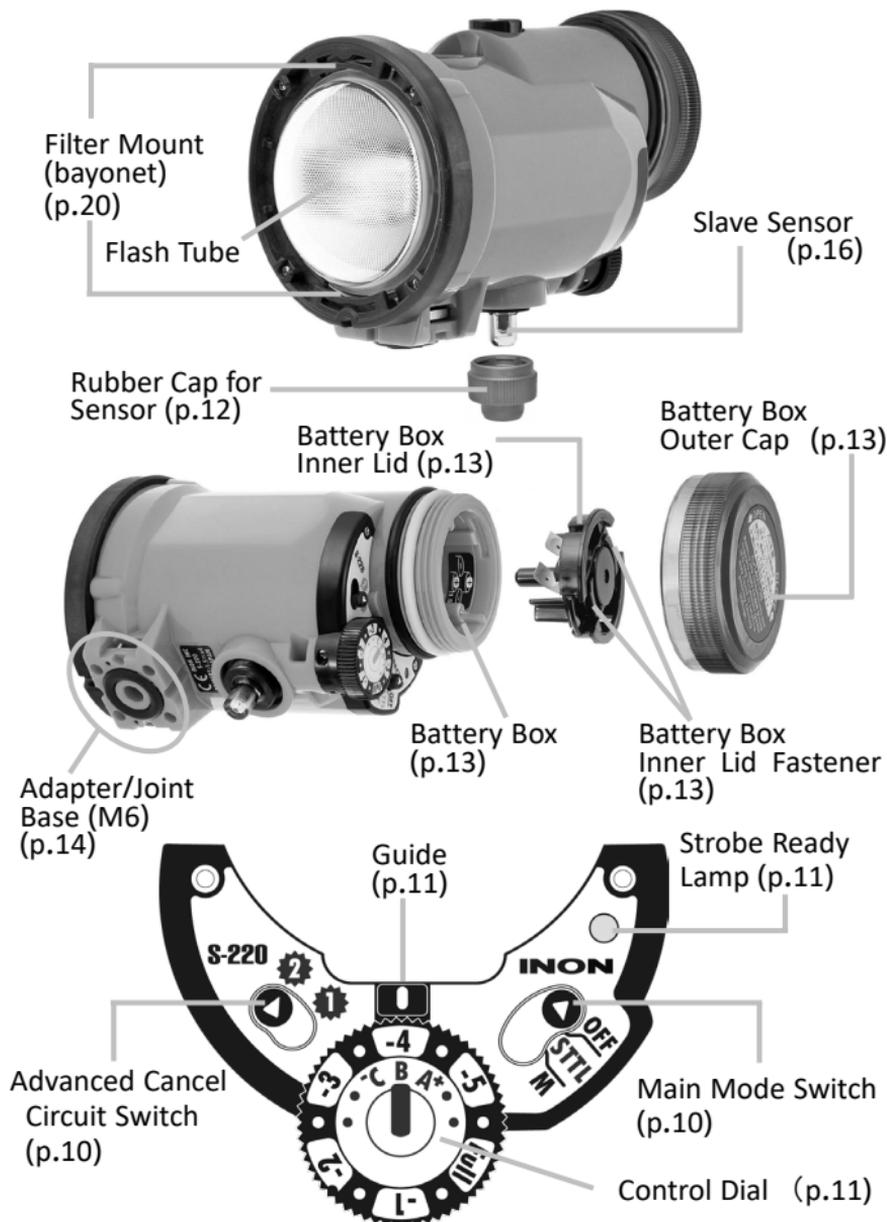

## Controls

### Main Mode Switch

**OFF** Turn OFF the strobe

**STTL** Automatic flash control  
*Not* usable for a digital camera *not* making pre-flash.

**M** Manual flash  
 When setting strobe output manually.



### Advanced Cancel Circuit Switch \*When shooting in M

Set either **1** or **2** depending on a camera to use with.



- Use with a camera making pre-flash --- Set to **2**
- Use with a camera *not* making pre-flash --- Set to **1**

**!** A pre-flash is a flash emitted before the main flash to determine the exposure. Depending on camera specifications or camera settings, the built-in flash may not emit a pre-flash. (See p. 19)

**!** The Advanced Cancel Circuit switch setting is required **only when using Manual mode (M)**. S-TTL Auto mode (**STTL**) works properly with any switch setting.

## Control Dial

1. When the Main Mode Switch is set to: **M**

**12 power settings available**

(Full to -5.5EV. with 0.5EV. increments)

2. When the Main Mode Switch is set to: **STTL**

**7 steps fine adjustment are available**

when used with a pre-flash type camera via fiber optics (within a range of red dots including A<sup>+</sup>, B and C)

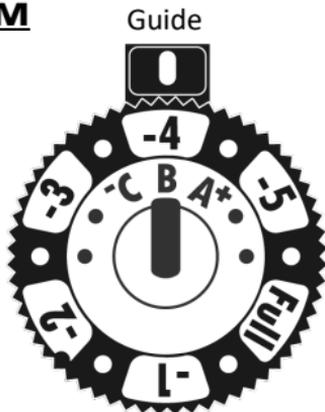

## Displays

### Strobe Ready Lamp

**Shines orange** when strobe becomes ready to flash.

 Insufficient battery capacity for proper functioning may cause 10 sec. (Alkaline battery)/5 sec. ("eneloop" battery) or more before you see orange light after power on the strobe. It would be advisable to change batteries before this happens.

 The Strobe Ready Lamp will be activated when the strobe has been charged about 80%. So please wait for another couple of seconds when the strobe requires to fire nearly full power both in Manual and S-TTL Auto mode.

# Preparation

## O-ring Maintenance

Conduct O-ring maintenance according to [Prevent Accidental Flooding](p. 7). Especially make sure to conduct maintenance of the Battery Box O-ring before loading batteries.

## Load Batteries

**!** **DO NOT** load batteries in the area to get splashed or with high humidity. The strobe must be dry. If this is not possible, make sure to thoroughly wash the S-220 in fresh water and completely wipe dry, then facing down the battery box cap to open so no water enters inside of the battery box.

This product requires four AA batteries of same type / model / capacity / charge status among below 5 categories

- AA "eneloop" battery (BK-3MCC) **[recommended]**
- AA "eneloop pro" battery (BK-3HCD) **[recommended]**
- AA Ni-MH battery (good quality)
- AA Alkaline battery
- AA Lithium battery (1.5V)

**1** Set Main Mode Switch to **[OFF]**



**!** The Slave Sensor must be covered by the pre-installed rubber cap to avoid accidental firing.



- 2** Remove the Battery Box Outer Cap by turning counterclockwise

 Make sure to turn the Battery Box Outer Cap **slowly** not to damage the Battery Box O-ring.



- 3** Unlock the Battery Box inner lid by pressing Battery Box Inner Lid Fasteners towards its center and pull up the entire lid.

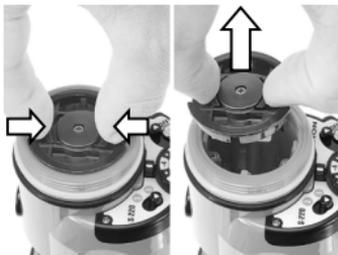

- 4** Load batteries with proper orientation indicated inside of the Battery Box.

 Be sure to install batteries with proper battery box. Using the strobe with wrong battery orientation can be very dangerous.



- 5** Align the notches on the Battery Box Inner Lid with the index ridges on the inside of the Battery Box, and press down the Battery Box Inner Lid. Make sure that you hear clicking sound and nail parts of the Battery Box Inner Lid properly seat in notches on the battery box.

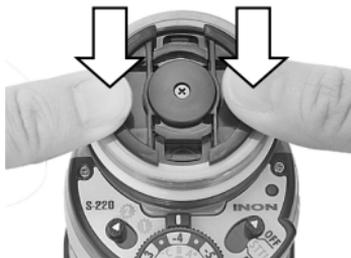

**6** Close the Battery Box Outer Cap by screwing clockwise.

 Stop screwing the cap when lightly stopped.  
(**DO NOT** tighten too much)

 Make sure to turn the Battery Box Outer Cap **slowly** not to damage the Battery Box O-ring.

**7** Visually check Battery Box O-ring to see if the O-ring is not came off (slipped off from O-ring groove) and is compressed uniformly with 1.5mm or wider flat area around the complete circumference.**Options to Connect to Camera**

Select either options below according to your housing or shooting condition and attach it on the strobe at Adapter/Joint Base (M6).

For detail, please refer to user manuals of respective housing, optional parts or our web site

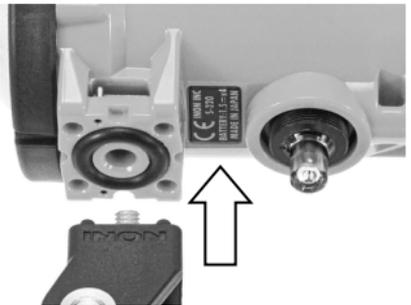

Z Adapter MV



Z Joint



Direct Base III



Quick Holder Set S-Z



## Connecting with Camera

Depending on camera/housing, necessary cable, compatible flash mode/strobe setting differs. This part explains connection method.

Please refer to [Taking a Photo] (p.16) for detailed setting when shooting.

Flash mode/Strobe setting		Optical Connection(Optical D Cable) Compatibility	
		Camera	Digital Camera
		Built-in Flash with Pre-flash	Built-in Flash Without Pre-flash
Manual (-5.5 - FULL)	Main Mode Switch	<b>M</b>	
	Advanced Cancel Circuit Switch	Set to <b>2</b>	Set to <b>1</b>
	Control Dial	12 steps	
Auto Exposure (S-TTL)	Main Mode Switch	<b>STTL</b>	/
	Advanced Cancel Circuit Switch	-----	
	Control Dial	7 steps	

## Optical Cable Connection

Connect with an Optical D Cable (option) to trigger this product by digital camera's built-in flash.

Variety of optional parts to fix an optical cable on different housing are available. Please contact your purchasing dealer or refer to our web site for detail of compatibility.

- 1 Set Main Mode Switch to **[OFF]**
- 2 Remove the rubber cap from the Slave Sensor.



### 3 Attach Sensor Plug of the Optical D Cable on the Slave Sensor.

 Screw the Sensor Plug straight in and stop tightening when it lightly stops.  
(**DO NOT** overtighten)



### 4 Attach the Optical D Cable on the housing Refer to respective user manuals of the housing/optional product.

## Taking a Photo

 When making sequential firing (series of flashes within 30 seconds interval), stop firing at accumulative numbers of flashes below to cool down the strobe 5 minutes or more

FULL	-	-1 EV.	:	10 times
-1.5 EV.	-	-3 EV.	:	30 times
-3.5 EV.	-	-6 EV.	:	50 times

In addition to above, turn OFF the strobe for 10 minutes or more when total flash numbers reach to below regardless of sequential or not sequential firing.

FULL	-	-1 EV.	:	50 times
-1.5 EV.	-	-3 EV.	:	100 times
-3.5 EV.	-	-6 EV.	:	150 times

When using STTL/Low, follow above procedure based on expected power output.

## Shoot with Optical Connection (Optical D Cable)

Turn off camera's red-eye reduction mode.

Select [force flash] or [fill-in flash] on camera's flash menu and turn off modeling light or AF assisting light. Refer to INON web site to see compatible digital cameras.

## Manual Flash

Control flash output manually.

**1** Set the Advanced Cancel Circuit Switch based on combined camera.

- Pre-flash digital camera: [Set to 2]
- No pre-flash digital camera: [Set to 1]

\*See p.19 for camera's flash setting.

**2** Set the Main Mode Switch to [M].



**3** Adjust flash output with the Control Dial.

- Dialing counter clockwise up to [-5.5] decreases flash output.
- Dialing clockwise up to [FULL] increases flash output.  
(12 steps with 0.5EV. increments)

\*When setting to [-4]

**4** Take a photo.

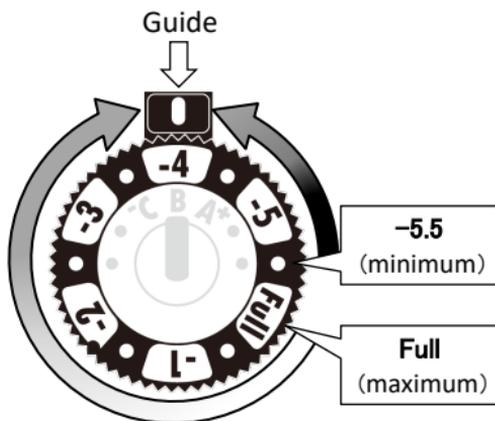

## S-TTL Auto

Pre-flash type digital camera can use the S-TTL Auto mode supported by fine output adjustment. \*See p.19 for camera's flash setting.

**!** S-TTL Auto mode doesn't support a camera not emitting pre-flash. (See p. 19 for detail of pre-flash)

- 1 Set the Main Mode Switch to [STTL]
- 2 Set the Control Dial to [B] position (12 o'clock position, [-4])
- 3 Take a photo.
- 4 If necessary adjust the output with the Control Dial.
  - Dialing counterclockwise increases the power.
  - Dialing clockwise decreases the power.
 (Total 7 steps within red dots including A+, B, C)



(Standard position **B**)

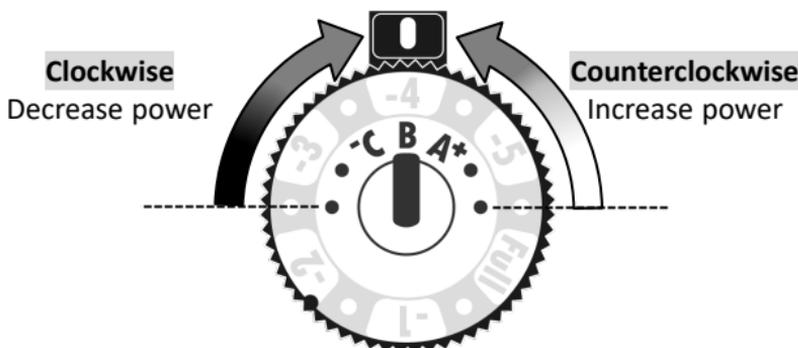

**!** Effectiveness of the fine adjustment in S-TTL Auto mode varies depending on combined camera or shooting condition. If it should not work as you wish, then use camera's exposure compensation or take procedure in the next page.

### ■ When images are overexposed

Try to change camera setting as one of below or in combination if power adjustment setting with minimum output still have overexposed or washed out images.

- 1 Use bigger f-number (close the aperture).
- 2 Locates strobe bit further from a subject.
- 3 Use lower ISO speed.

### ■ When images are underexposed

Try to change camera setting as one of below or in combination if power adjustment setting with maximum output still have underexposed or black out images.

- 1 Use smaller f-number (open the aperture).
- 2 Locates strobe close to a subject.
- 3 Use higher ISO speed.

### ■ When images show blue cast

Try to change camera setting as one of below or in combination if you see bluish image overall without natural color.

- 1 Use faster shutter speed.
- 2 Use lower ISO speed.

## Pre-flash

There is a flash mode of camera **not** making a pre-flash, like setting flash value manually on Olympus TG-6, not allowing to use S-TTL Auto mode and requiring Advanced Cancel Circuit Switch set to 1 when using Manual mode.



A camera does pre-flash

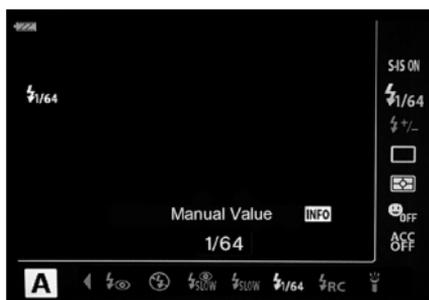

A camera does **not** pre-flash

## Using Strobe Dome Filter S

### **Strobe Dome Filter S [SOFT]** \*Preinstalled on the strobe

Diffuses and softens strobe light. Attaching this filter widens strobe beam angle to horizontal  $150^{\circ}$  x vertical  $110^{\circ}$  (approx. 0.5EV. decrease underwater). Use this filter only when you prefer [soft flash light], [to widen strobe coverage] or [to protect front dome of the strobe]. Otherwise use the strobe without this filter.

### **Strobe Dome Filter S [ND]** \*Packaged as standard accessory

Cut strobe output at [4 EV.]. Useful when shooting a subject with [close strobe position], [open aperture] or [high ISO], or [a fluorescent subject].

## ■ Installation

- Put the Strobe Dome Filter S on the strobe front dome so that protruded flanges located on 12/6 o'clock positions around strobe front dome seat in cutouts of the Strobe Dome Filter S as in the right image.
- Rotate the Strobe Dome Filter S clockwise until you feel click where you should hear click sound.



The Strobe Dome Filter S has holes for lanyard to strap to strobe arm etc.

\*A lanyard is not bundled.



## After Use Maintenance, Storage

### Desalt, Clean, Dry

- 1 Soak the strobe in freshwater within operable temperature (0°C–30°C/32°F - 86°F) as it is for several hours to remove salt build-up.
- 2 Slowly move switches and dial to remove trapped sands and salt during above procedure.

 **DO NOT** unscrew/retighten the Battery Box Outer Cap

- 3 Blow off remaining water droplets by compressed air etc. and dry well the strobe in shaded, well-ventilated area within storage temperature range [0°C - 30°C/32°F - 86°F]

 Never apply flame or direct heat or damage may result

- 4 After surface is thoroughly dry, remove the Battery Box Outer Cap and Inner Lid to remove batteries from the Battery Box and continue to dry with the Battery Box open. It may take several days for moisture in the small gaps and recesses of the strobe to completely dry.

### When iron sands adhere to switches

If you observe iron sands around switches, use air blower to blow them away from the direction indicated by arrows in below right image. In case iron sands are trapped and can not take them away (you may not feel clicking of the switch as like before), the unit needs to be checked and repaired properly. Please contact your purchasing dealer or Inon authorized service center.

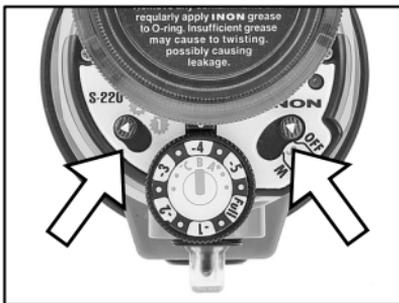

## O-ring Maintenance

After completely dry, inspect/grease O-ring in accordance with [Prevent Accidental Flooding (p.7)]

## Battery Terminals/Battery Box Contacts Maintenance

- 1 Gently bend the terminals back to the correct position, if they have been bent.

**Correct**



**Bent**



- 2 Clean battery terminals, Battery Box Inner Lid contacts and Battery Box contacts.

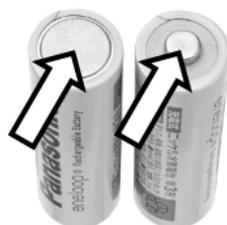
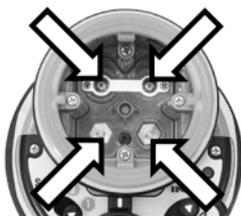

## ■ Cleaning Procedure

 When cleaning battery terminals, always check and follow precautions/restrictions of the battery

 Make sure not to put chemical other than terminals

- 1 Wipe terminal surface with a cotton swab (or similar) soaked in alcohol to remove any oil or similar residue.
- 2 (Only if the strobe shows unstable operation like suddenly stop charging and above step does not solve the problem) dap a small amount of silver polish on a cotton swab (or similar) and wipe terminal surface to remove oxidized film. Then clean off any silver polish residue with a clean swab.

## Overhaul

To keep optimum performance of this product, it is necessary to receive periodic overhaul at INON or authorized service facility.

O-rings and other degradable parts life can vary considerably due to type of use, frequency of use, storage conditions etc., INON recommends overhaul once per year to prevent accidental flooding.

## Storage

 Always remove batteries during storage

Close the Battery Box Outer Cap and store out of direct sunlight in well-ventilated, dry area within storage temperature [0°C - 30°C /32°F - 86°F].

Avoid storing near chemicals (camphor or naphthalene etc.), magnetic fields (TV etc.) and large temperature fluctuations (even within storage temperature).

It would be recommended to put a desiccant agent in the battery box during storage.

When not using the strobe for extended period, put in a set of batteries, test fire once, turn the Main Mode Switch to OFF when the red ready lamp comes on and remove batteries to prevent degradation of internal circuitry about once a month or so during the storage period.

## Trouble Shooting

When you doubt malfunction of the product, please check below first then consult your purchasing dealer if problem remains.

### Power

If Strobe Ready Lamp does not come on.

- Compatible batteries are loaded? (p.12)
- Loaded batteries are with proper orientation? (p.13)

If charging takes longer.

- Batteries have been sufficiently charged? (p.11)
- Batteries degradation? (p.11)
- Dirt on battery terminals, battery box contacts? (p.22)

### Basic Operation

If strobe doesn't fire...

- Is the Optical D Cable properly connected? (p.15-16)
- Has the Optical D Cable got damaged or got dirt on its bear end? (p.15-16)
- Does camera's built-in flash fire? (p.16)

### Exposure Control

If Manual flash mode gives underexposed images....

- Camera's built-in flash makes pre-flash or not....(p.17)
- Advanced Cancel Circuit Switch is properly set? (p.15)
- Check compatible digital cameras on INON web site.

If Manual flash mode gives overexposed images (the strobe always delivers FULL)....

- Advanced Cancel Circuit Switch is properly set? (p.15)
- Check compatible digital cameras on INON web site.

S-TTL Auto gives underexposed images....

- Does camera's built-in flash make pre-flash?
- Check compatible digital cameras on INON web site.

S-TTL Auto always gives FULL dump....

- Is the Optical D Cable properly set? (p.15-16)
- Has Optical D Cable got damaged or got dirt on its bear end? (p.15-16)
- Check compatible digital cameras on INON web site.

## After Service

Please contact your purchasing dealer for any questions about this product.

Please contact your purchasing dealer for product inspection/repair.

The S-220 sold by authorized overseas distributor/dealer carries limited warranty provided by the distributor/dealer. Warranty repair will be provided according to the warranty terms and conditions. In principle, repair service is not free of charge after the warranty period has expired. A customer is required to bear shipping costs to and from INON's designated repair facility. Please contact your authorized INON distributor/dealer for warranty service or warranty condition.

### Manufacturer

INON INC.

2-18-9, Dai, Kamakura

Kanagawa 247-0061 JAPAN

E-mail [support@inon.co.jp](mailto:support@inon.co.jp)

Fax. +81 (0)467-48-2178

URL <http://www.inon.jp/>

### Update history

• July, 2023

Ver.1.0.0

# Specifications

Model	S-220
Flash Mode (*1)	S-TTL Auto/Manual
Connection	Optical Connection (Optical D Cable)
Guide Number at FULL(*2)	22 [without a filter] 19 [with Strobe Dome Filter S [SOFT]] 5.6 [with Strobe Dome Filter S [ND]]
Settable flash output (GN) in Manual mode (*2)	22 (FULL), 19 (-0.5), 16 (-1), 13 (-1.5), 11 (-2), 9.5 (-2.5), 8.0 (-3), 6.7 (-3.5), 5.6 (-4), 4.8 (-4.5), 4.0 (-5), 3.5 (-5.5) (12 steps in 1/2EV increments) *( ) stands for Control Dial position
Beam Angle	140°(horizontal)×100°(vertical) [without a filter] 150°(horizontal)×110°(vertical)[with Soft Dome Filter S [SOFT]]
Color Temperature	Approx. 5500K [without a filter] Approx. 5400K [with Strobe Dome Filter S [SOFT]]
Recycle Time at FULL (*3)	Approx. 2.1 seconds minimum ["eneloop" batteries] Approx. 2.0 seconds minimum ["eneloop pro" batteries] Approx. 2.5 seconds minimum [Alkaline batteries] Approx. 3.5 seconds minimum [Lithium 1.5V batteries]
Flash Capacity at FULL (*3)	Approx. 380 flashes ["eneloop" batteries] Approx. 500 flashes ["eneloop pro" batteries] Approx. 350 flashes [Alkaline batteries] Approx. 640 flashes [Lithium 1.5V batteries]
Compatible Battery	AA "eneloop" battery x 4(Model:BK-3MCC)【Recommended】 AA "eneloop pro" battery x 4(Model:BK-3HCD) 【Recommended】 AA Ni-MH battery (*4) x 4 AA Alkaline battery (*4) x 4 AA Lithium battery (1.5V) (*4) x 4
Dimensions	Diameter:80mm/3.1in.,Height:91mm/3.6in., Depth:128mm/5.0in. excluding protruded parts
Weight (air)	348g/12.3oz [without a filter, batteries] 463g/16.3oz [with 4 x eneloop batteries]
U/W Weight	Approx. 50g/1.8oz [with 4 x eneloop batteries]
Working Temp.	0°C - 30°C/32°F - 86°F *water temperature
Storage Temp.	0°C - 30°C/32°F - 86°F *air temperature
Depth Rating	100m/328ft
Body Material	Body: Polycarbonate/red
Package Contents	Strobe Dome Filter S [SOFT], Strobe Dome Filter S [ND], Rubber Cap for Sensor, INON grease
EMC Standards	EN 55015:2019+A11:2020, EN 61547:2023, CRF 47 FCC Part 15, ICES-003:2020(Issue 7)

## Specifications (continued)

---

- \*1 Compatible flash mode varies depending on combined camera system. Refer to this user manual for detail.
- \*2 Measurement in air/ISO100 at 1 m, nominal value.
- \*3 INON test data (reference data). Measured with FULL strobe output at 30-second intervals with Advanced Cancel Circuit switch being set to [1], at 25°C/77°F with test batteries giving 5 minutes cooling period every 50 flashes.

### Test battery

"eneloop":	Panasonic "eneloop", BK-3MCC, 1.2V, Min.1,900mAh
"eneloop pro":	Panasonic "eneloop pro", BK-3HCD, 1.2V, Min.2,500mAh
Alkaline:	Panasonic "EVOLTA NEO", LR6NJ, 1.5V
Lithium (1.5V):	Energizer ULTIMATE LITHIUM, L91, 1.5V

- \*4 Not all batteries are confirmed compatible. To prevent battery issues such as battery leak, refer to \*3 and use good quality batteries that are capable of continuous discharge at high currents.

Specifications, performance subject to change without prior notice.

As of July 2023

### FCC Notice

This device complies with part 15 of the FCC Rules. Operation is subject to the following two conditions:

1. This device may not cause harmful interference, and
2. This device must accept any interference received, including interference that may cause undesired operation

### Information to user

The user that changes or modifications not expressly approved by the party responsible for compliance could void the user's authority to operate the equipment.

Note: This equipment has been tested and found to comply with the limits for a Class B digital device, pursuant to part 15 of the FCC Rules. These limits are designed to provide reasonable protection against harmful interference in a residential installation. This equipment generates, uses and can radiate radio frequency energy and, if not installed and used in accordance with the instructions, may cause harmful interference to radio communications. However, there is no guarantee that interference will not occur in a particular installation.

If this equipment does cause harmful interference to radio or television reception, which can be determined by turning the equipment off and on, the user is encouraged to try to correct the interference by one or more of the following measures:

- Reorient or relocate the receiving antenna.
- Increase the separation between the equipment and receiver.
- Connect the equipment into an outlet on a circuit different from that to which the receiver is connected.
- Consult the dealer or an experienced radio/TV technician for help.

### ICES-003 Notice

This Class B digital apparatus complies with Canadian ICES-003.

### Avis NMB-003

Cet appareil numérique de la classe B est conforme à la norme NMB-003 du Canada.