

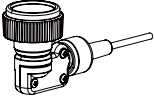

INON

Strobe - Optical Cable Compatibility

All INON Optical Cable products have been upgraded to "Type L" equipping "L-Connector" upon Z-240 Type4 / D-2000 Type4 introduction. Old type Optical Cable product (non Type L, non-wireless) which does not support connection with Z-330 / D-200 / Z-240 Type4 / D-2000 Type4 requires replacing connector to "wireless type".

New "Type L" product requires replacing connector to "non-wireless type" to use for Z-240 Type3 / D-2000 Type3 and other previous model. Refer below chart to use appropriate connector. For detail of replacement of connector, refer to "L-Connector Modification Instruction".

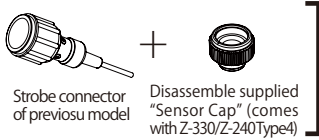
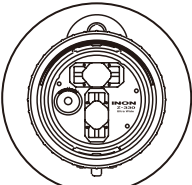
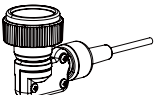
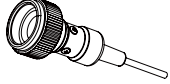
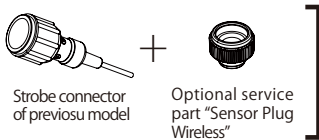
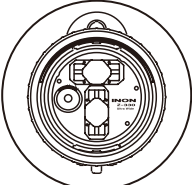
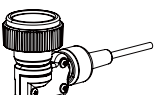
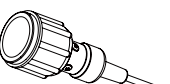
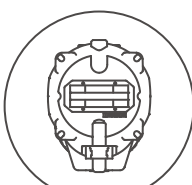
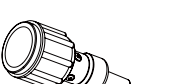
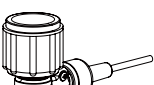
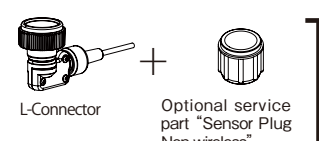
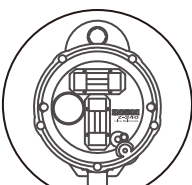
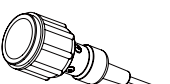
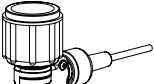
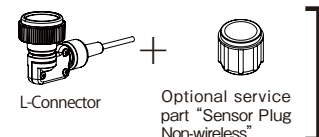
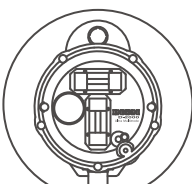
Optical Cable	Strobe
 <p>L-Connector • Wireless type</p>  <p>Straight Connector • Non-wireless</p>	<p>Compatible with pre-installed L-Connector.</p>  <p>Replace the straight connector with component part of supplied "Sensor Cap" for Z-330/Z-240 Type4 to use with wireless type strobe. Optional service part "Sensor Plug Wireless" is also usable.</p>  <p>Z-330 Z-240 Type4 Slave Sensor diameter is approx. 8mm</p>
 <p>L-Connector • Wireless type</p>  <p>Straight Connector • Non-wireless</p>	<p>Compatible with pre-installed L-Connector.</p>  <p>Replace the straight connector with optional service part "Sensor Plug Wireless" to use with wireless type strobe.</p>  <p>D-200 D-2000 Type4 Slave Sensor diameter is approx. 8mm</p>
 <p>L-Connector • Wireless type</p>  <p>Straight Connector • Non-wireless type (old type, black plastic)</p>	<p>Compatible with pre-installed L-Connector.</p> <p>Compatible with pre-installed L-Connector.</p>  <p>S-2000 Slave Sensor diameter is approx. 8mm Compatible with wireless and non-wireless type Optical Cable</p>
 <p>Straight Connector • Non-wireless type (old type, black plastic)</p>  <p>L-Connector • Non-wireless</p>	<p>Compatible with pre-installed L-Connector.</p>  <p>Replace pre-installed L-Connector with optional service part "Sensor Plug Non-wireless".</p>  <p>Z-240 Type3/Type2/type1 Slave Sensor diameter is approx. 15mm</p>
 <p>Straight Connector • Non-wireless type (old type, black plastic)</p>  <p>L-Connector • Non-wireless</p>	<p>Compatible with pre-installed L-Connector.</p>  <p>Replace pre-installed L-Connector with optional service part "Sensor Plug Non-wireless".</p>  <p>D-2000 Type3/Type2/type1 Slave Sensor diameter is approx. 15mm</p>

INON

INON L-Connector Modification Instruction

Important Notice

This is a guidance to explain about “Optical D Cable Type L” products how to change its L-Connector from **[wireless type]** to **[non-wireless type]**. Refer to respective product user manual for detail of each product.

Contact your purchasing dealer for assistance if you are not confident to exercise this modification. INON INC. can not take any responsibility on personal injury, accident or damage on product resulting from the modification.

Illustrations and images may be different from actual parts/products.

L-Connector

Pre-installed L-Connector on “Optical D Cable Type L” products is **[wireless type]** and necessary to replace with optional **[non-wireless type]** L-Connector to use for non-wireless strobes.

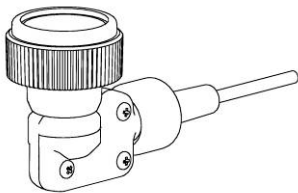

“Wireless type” L-Connector

[Compatible strobe] (as of September 2018)
Z-330, D-200, Z-240 Type4, D-2000 Type4, S-2000

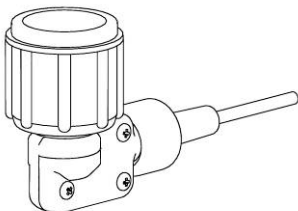

“Non-wireless type” L-Connector

[Compatible strobe] (as of September 2018)
Z-240 Type3/Type2/Type1
D-2000 Type3/Type2/Type1
S-2000 (both L-Connector type is usable)
D-2000S Type2/Type1, D-2000W/Wn,
Z-220 series, D-180series,
INON TTL Sensor Z/SB/YS, INON Focus Light Controller

Name of Parts

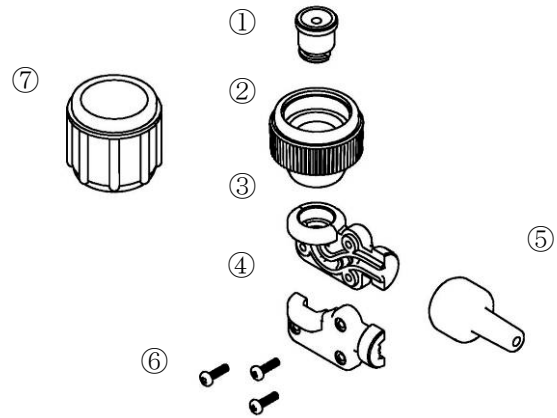

- ① L Cable Anchor
- ② Sensor Plug Wireless
- ③ L-Connector Body
- ④ L-Connector Cover
- ⑤ L Cable Cover
- ⑥ Screws
- ⑦ Sensor Plug Non-wireless (optional)

Necessary tool: Precision screw driver (+)#0

Construction of “L-Connector Body” and “L Cable Anchor”

To separate “L-Connector Body” and “L Cable Anchor”, it is essential to understand how they are coupled each other.

Both parts have “D” shaped portion (“D Cut”) and these two parts are joined/removed when their “D Cut” match each other. When connecting these two parts, after matching their “D Cut”, rotate 180 degrees to lock not to separate these parts.

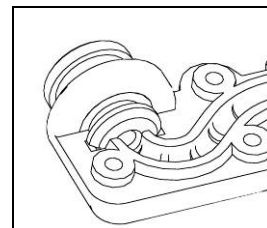
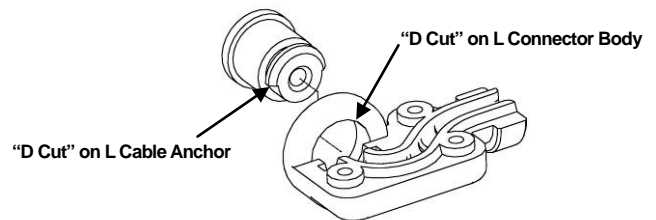

Unlocked
Both “D Cut” are
matched.

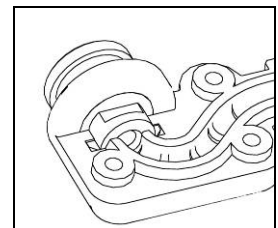

Locked
Both “D Cut” are not
matched.

How to disassemble L-Connector Wireless

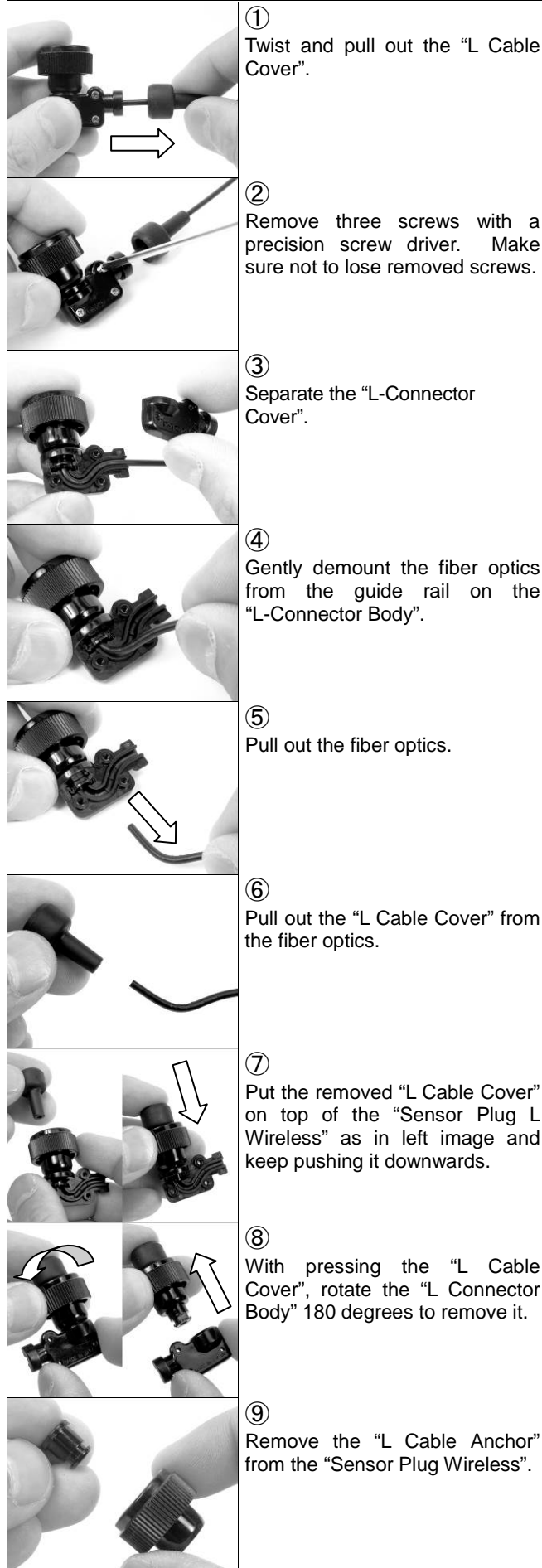

How to assemble L-Connector non-wireless

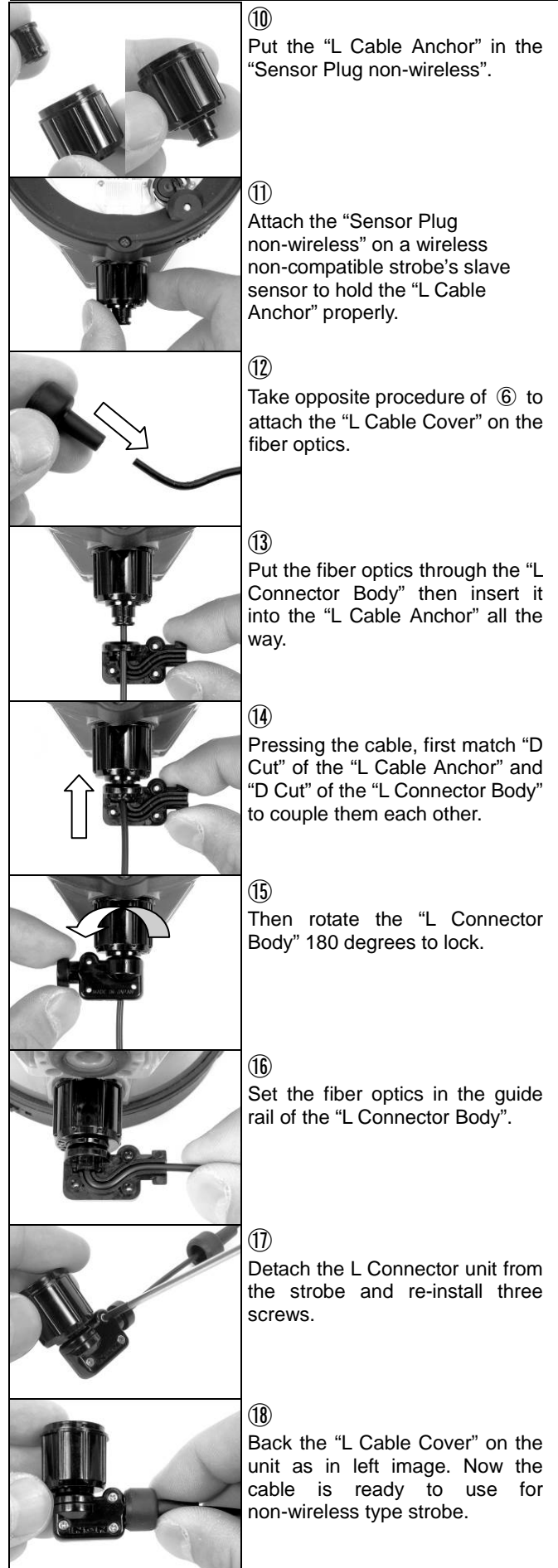

INON Inc.

2-18-9, Dai, Kamakura, Kanagawa 247-0061 JAPAN

E-mail support@inon.co.jp Fax +81(0)467-48-2178

URL <http://www.inon.co.jp/>

September 2018